

FITTING INSTRUCTION

Clamp mark in acc. with		Cables joining
ISO	PN	
1	L	Left directional lights
2	+	Rear fog lights
3	31	Ground
4	R	Right directional lights
5	58R	Right side parking lights
6	54	Stoptlights
7	58L	Left side parking lights

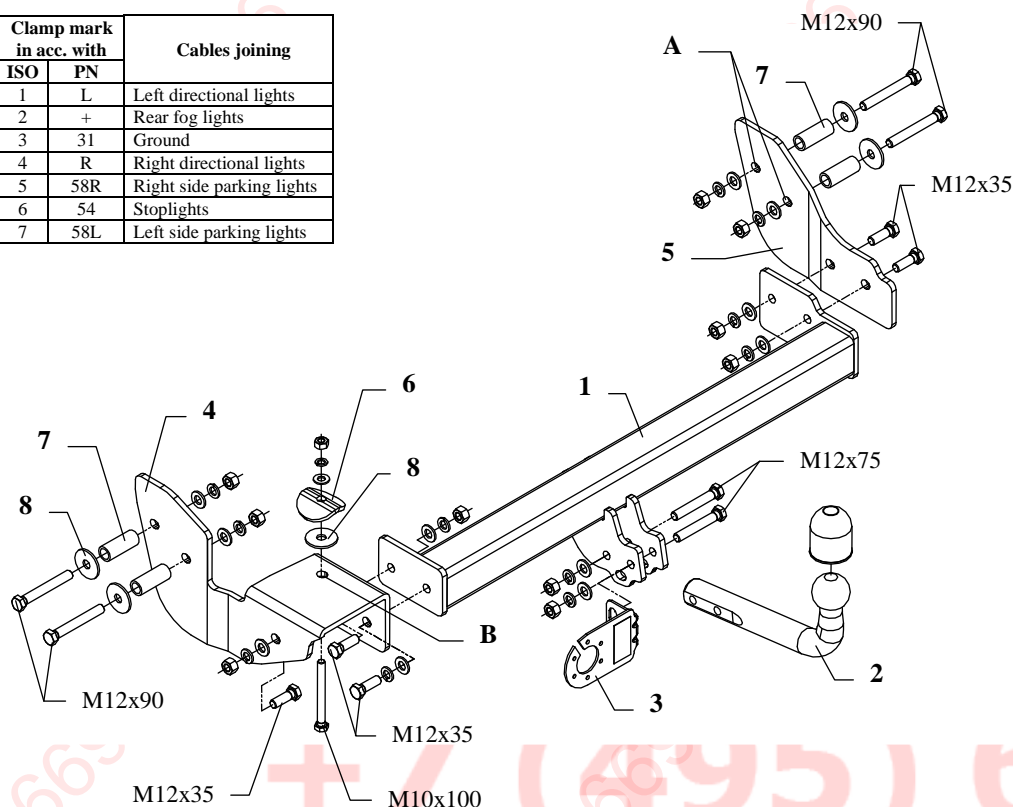

This towing hitch is designed to assembly in following cars: **KIA SPORTAGE, 5 doors, 2WD, 4WD**, produced since 1994 till 2004, catalogue no. **T10** and is prepared to tow trailers max total weight **2000 kg** and max vertical load **75 kg**.

From manufacturer

Thank you for buying our product. Their reliability has been confirmed in many tests. Reliability of towing hitch depends also on correct assembly and right operation. For this reasons we kindly ask to read carefully this instruction and apply to hints.

The towing hitch should be install in points described by a car producer.

The instruction of the assembly

1. Cut out the template and apply it to the internal side of the frame. The template one ought to place that way, so holes in the shape of the ellipse in the frame be covered with the cut on the template and the semicircle on the template be covered with the pipe which joins both frames. After careful arrangement of the template one ought to point three holes (from template).
 2. In pointed places one ought to drill throughly holes $\varnothing 13\text{mm}$, then holes (pos. A) by the outside of the frame drill $\varnothing 22\text{mm}$.
 3. Into so prepared holes slip distance sleeves $\varnothing 21,6 \times 2,65\text{mm}$, $L=53\text{mm}$ (pos. 7), put bolts M12x90mm (pos. 9) with washers $\varnothing 42 \times \varnothing 13 \times 3\text{mm}$ (pos. 8).
 4. Apply brackets (pos. 4 and 5) to the internal side of the frame, as showed on the drawing and fix loosely.
 5. Slip the main bar of the towing hitch (pos. 1) between brackets (pos. 4 and 5) and fix with bolts M12x35mm (pos. 11).
 6. Through hole (pos. B) of the bracket (pos. 4) drill throughly in the joining pipe of the frame hole $\varnothing 11\text{mm}$, then fix with bolt M10x100mm (pos. 12). Use the washer (pos. 6).
- ATTENTION!** Between the bracket (pos. 4) and the pipe put washers $\varnothing 42 \times \varnothing 13 \times 3\text{mm}$ (pos. 8), as showed on the drawing.
7. Fix tow-ball (pos. 2) and socket plate (pos. 3) by bolts M12x75mm (pos. 10) from accessories.
 8. Tighten all bolts according to the torque shown in the table.
 9. Connect electric wires of 7-poles socket according to the instruction of the car. (Recommend to make at authorized service station)
 10. Complete paint layer damaged during installation.

Torque settings for nuts and bolts (8,8):	
M 8 - 25 Nm	M 10 - 55 Nm
M 12 - 85 Nm	M 14 - 135 Nm











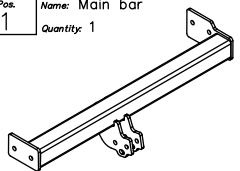

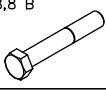



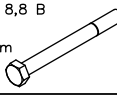

NOTE

After install the towing hitch you should get adequate note in registration book (at authorised service station). The car should be equipped with:

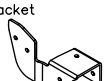
- Indicators
- Tow mirrors

After 1000km check all bolts and nuts. The ball of towing hitch must be always kept clear and conserve with a grease.

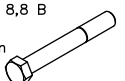
Towing hitch accessories:

Pos. 1 Name: Main bar Quantity: 1 	Pos. 5 Name: Right bracket Quantity: 1 	Pos. 10 Name: Bolt 8,8 B Quantity: 2 Dim.: M12x75mm 	Pos. 15 Name: Plain washer Quantity: 11 Dim.: Ø 13 mm 
Pos. 2 Name: Tow ball Quantity: 1 	Pos. 6 Name: Washer Quantity: 1 Dim.: Ø58xØ12x6mm 	Pos. 11 Name: Bolt 8,8 B Quantity: 5 Dim.: M12x35mm 	Pos. 16 Name: Plain washer Quantity: 1 Dim.: Ø 10,5 mm 
Pos. 3 Name: Socket plate Quantity: 1 	Pos. 7 Name: Distance sleeve Quantity: 4 Dim.: Ø21.6x2.65mm L=53mm 	Pos. 12 Name: Bolt 8,8 B Quantity: 1 Dim.: M10x100mm 	Pos. 17 Name: Spring washer Quantity: 11 Dim.: Ø 12,2 mm 
Pos. 4 Name: Left bracket Quantity: 1 	Pos. 8 Name: Flat washer Quantity: 5 Dim.: Ø42xØ13x3mm 	Pos. 13 Name: Nut 8 B Quantity: 10 Dim.: M12 	Pos. 18 Name: Spring washer Quantity: 1 Dim.: Ø 10,2 mm 
	Pos. 9 Name: Bolt 8,8 B Quantity: 4 Dim.: M12x90mm 	Pos. 14 Name: Nut 8 B Quantity: 1 Dim.: M10 	Pos. 19 Name: Ball cover Quantity: 1 



PPUH AUTO-HAK S.J.

Produkcja Haków Holowniczych
Henryk & Zbigniew Nejman
76-200 SŁUPSK ul. Słoneczna 16K
tel/fax (059) 8-414-414; 8-414-413
e-mail: office@autohak.com.pl
www.autohak.com.pl

Towing hitch (without electrical set)

Class: **A50-X** Cat. no. **T10**

Designed for:

Manufacturer: **KIA**

Model: **SPORTAGE**

Type: **5 doors, 2WD, 4WD**

produced since 1994 till 2004

Technical data:

D-value: 9,89 kN

maximum trailer weight: **2000 kg**

maximum vertical cup load: **75 kg**

Approval number according to Directive 94/20/EC: **e20*94/20*0302*00**

Foreword

This towing hitch is designed according to rules of safety traffic regulations. The towing hitch is a safety component and can be install only by qualified personnel. Any alteration or conversion of the towing hitch is prohibited and would lead to cancellation of design certification. Remove insulating compound and underseal from vehicle (if present) in the area of the matting surfaces of the towing hitch. The vehicle manufacturer's specifications regarding trailer load and max. vertical cup load are decisive for driving whereat values for the towing hitch cannot be exceeded.

D-value formula:

$$\frac{\text{Max trailer weight [kg]} \times \text{Max vehicle weight [kg]}}{\text{Max trailer weight [kg]} + \text{Max vehicle weight [kg]}} \times \frac{9,81}{1000} = D \text{ [kN]}$$